

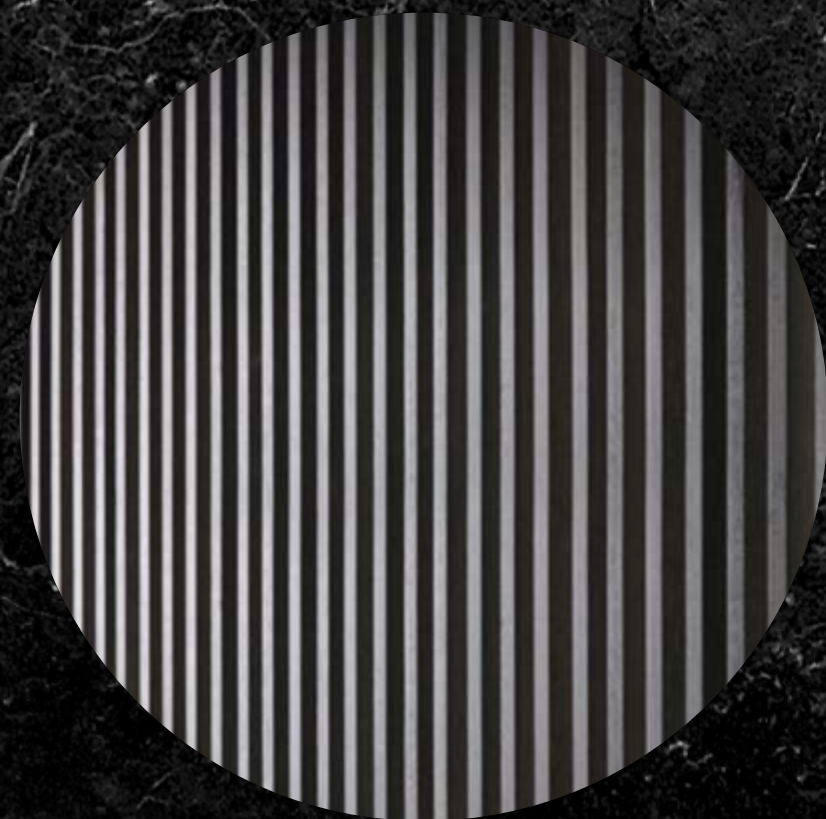

DAR AL ARKAN



TOWER  
DA VINCI  
Interiors by  
PAGANI

PAGANI

DAR AL ARKAN

“Art and science are disciplines  
that can walk hand in hand”

*Leonardo Da Vinci*

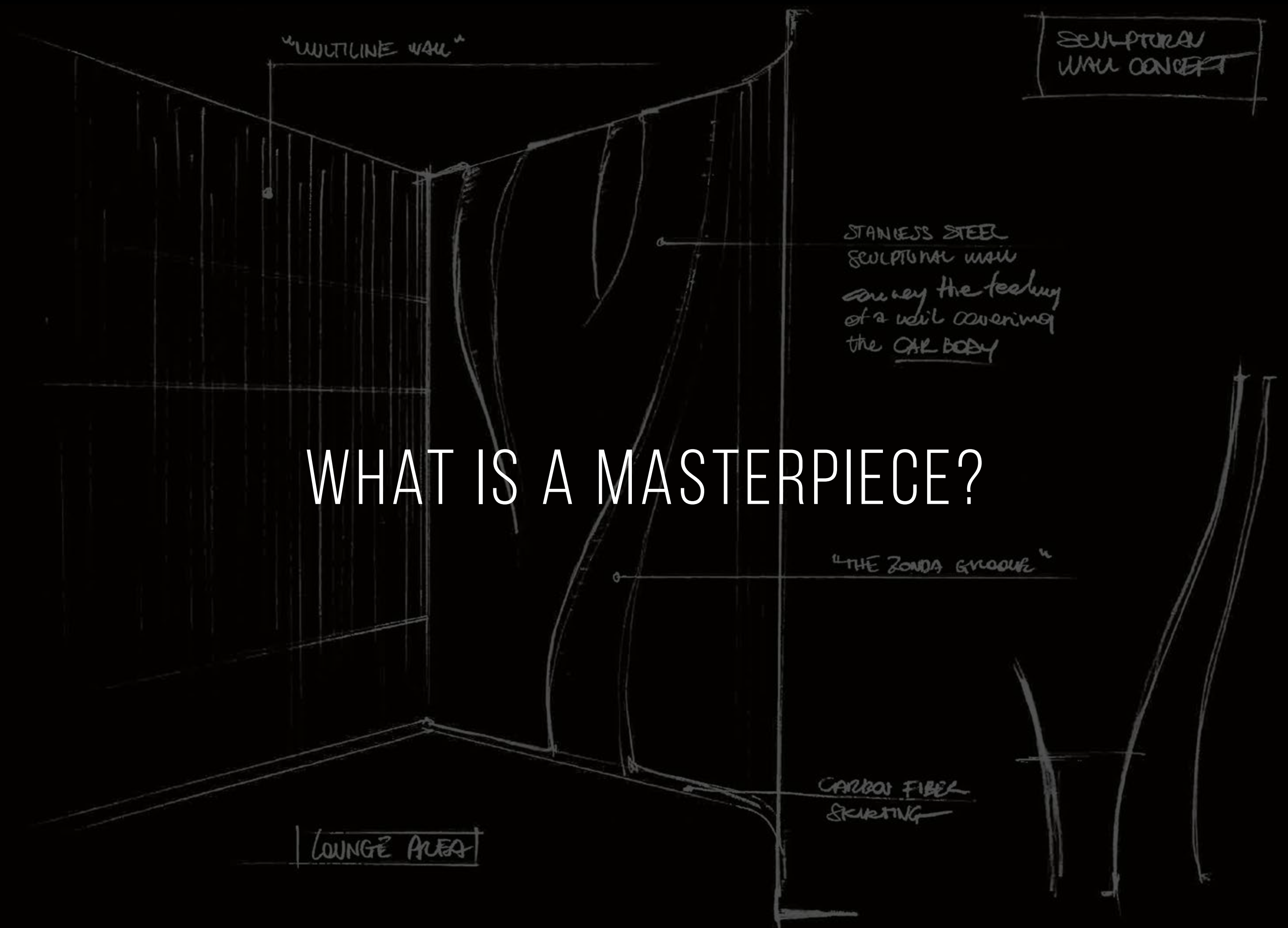

# WHAT IS A MASTERPIECE?

IS IT MAGNETIC *beauty* MADE OF SINUOUS LINES?



IS IT ENGINEERING *marvel*  
PURSUING UNPRECEDENTED PERFORMANCES?

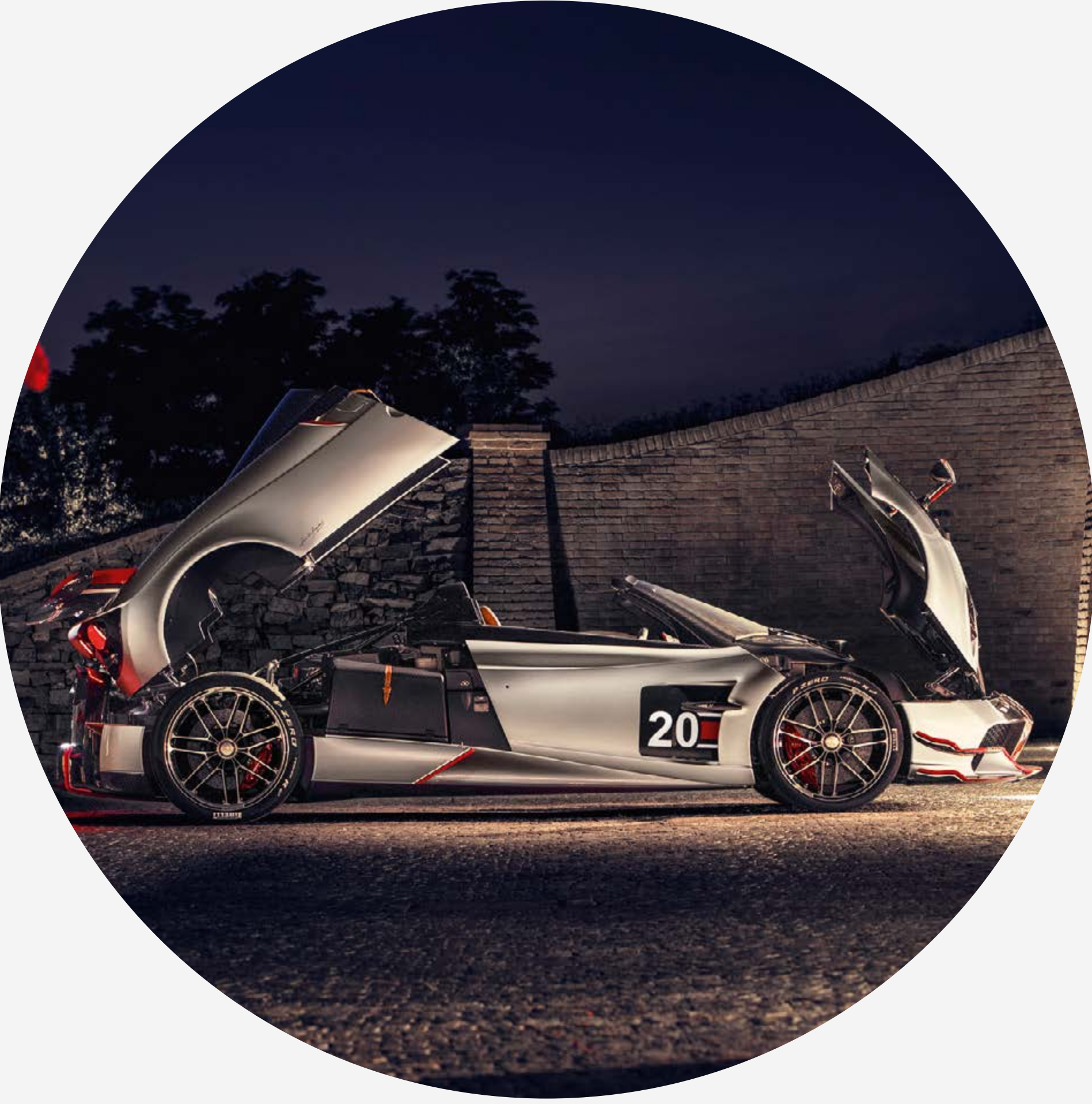
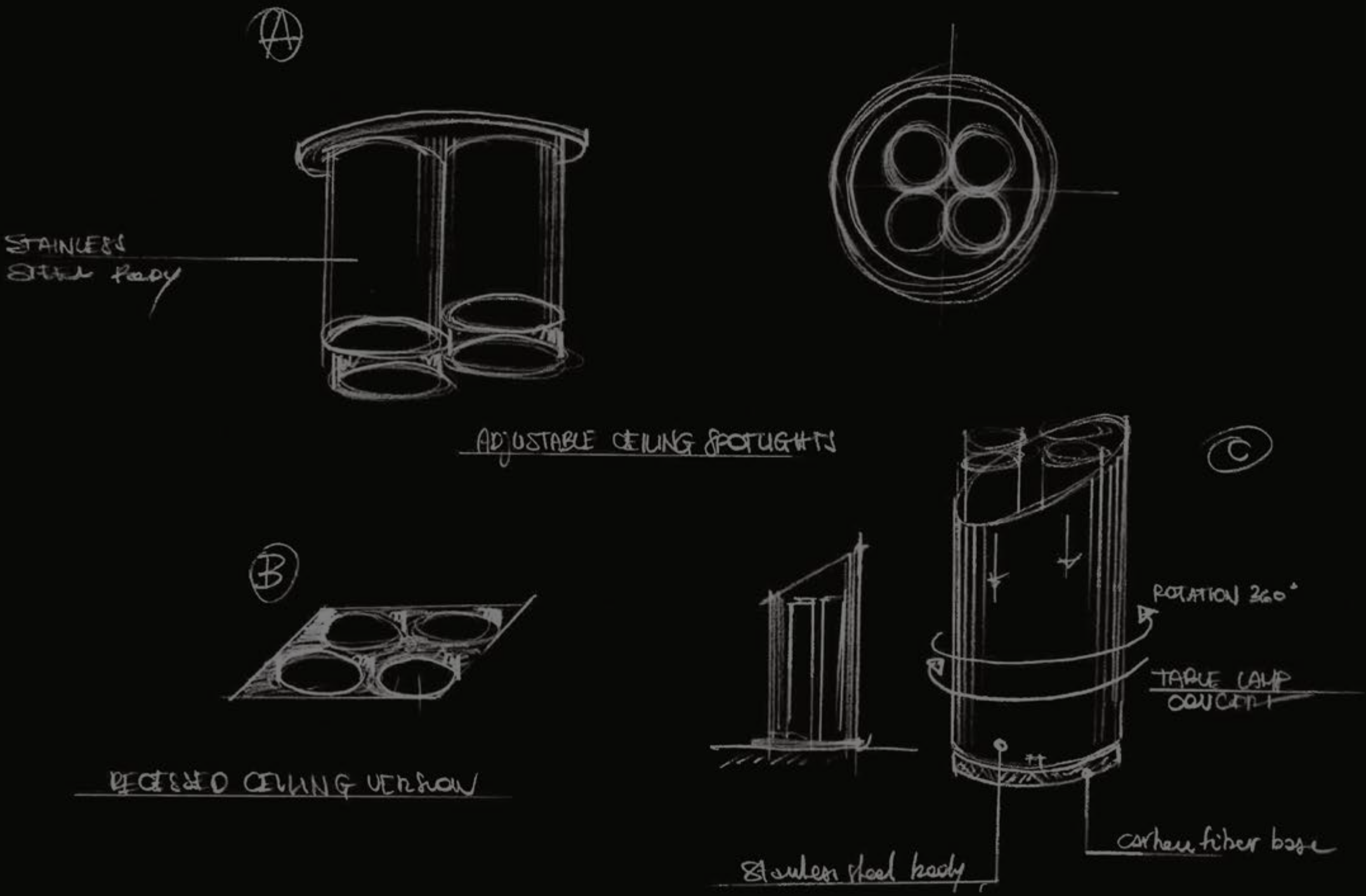

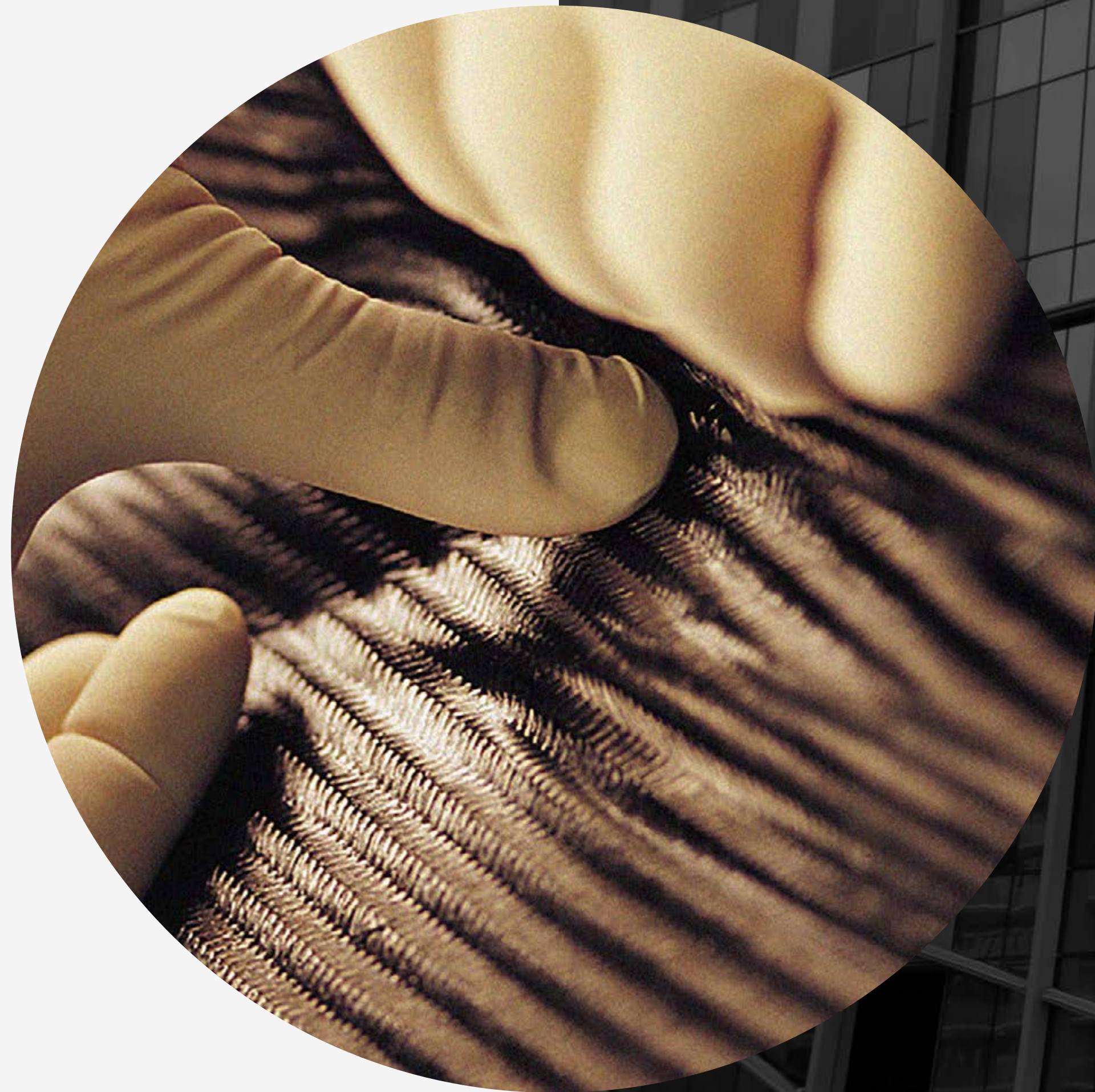

IS IT TAILOR-MADE *details* CRAFTED  
TO EXTREME PERFECTION?

IT IS ALL OF IT. AND WAY MORE.



DAR AL ARKAN





# CREATURES *of* ART

---



Horacio Pagani had a dream, and his dream was to create the most beautiful car in the world. Not only he succeeded, but he created a universe that goes beyond the automotive field, a dimension that only few can aspire to. With Leonardo Da Vinci's intuition in mind, Horacio blended beauty and function together, giving life to the unprecedented world of Pagani.



# THE SHAPE OF *speed*

---

Pagani's first residences ever are brought to life in a unique tower. The building design is one that makes your head turn: the instability of lines, a strong uneven approach, transparency and hidden balances create a dynamic effect like no other in the surroundings. But it's when you get closer that you discover the pearl, an incredible suspended sphere that defies gravity. The tower is a true geometric symphony of perfection with 19 floors of residential masterpieces, 3 basement levels and a majestic ground floor.





## AT THE CORE OF *contemporaneity*

Dubai is likely becoming the art capital of the 21st century. Home to the most prominent exhibitions, fashion shows, arts and cultural events, DaVinci Tower sits at the heart of it all.

The building is directly by the Dubai Canal, overlooking the world's tallest building Burj Khalifa and a stone throw away from Marasi Business Bay. A prime location filled with a unique mix of aesthetic residential and commercial towers, attracting the most affluent people from around the world.

# LOCATION

DIRECTLY ON  
**THE DUBAI CANAL**

A 3.2 Km-long tourist landmark

5 MINUTES  
**THE DUBAI MALL**

The world's largest retail & entertainment destination

4 MINUTES  
**THE DUBAI FOUNTAIN**

The world's tallest performing fountain with a captivating water, music & light spectacle

7 MINUTE  
**BURJ KHALIFA**

The world's tallest building

7 MINUTES  
**THE DUBAI OPERA**

2000 seat multi-format venue

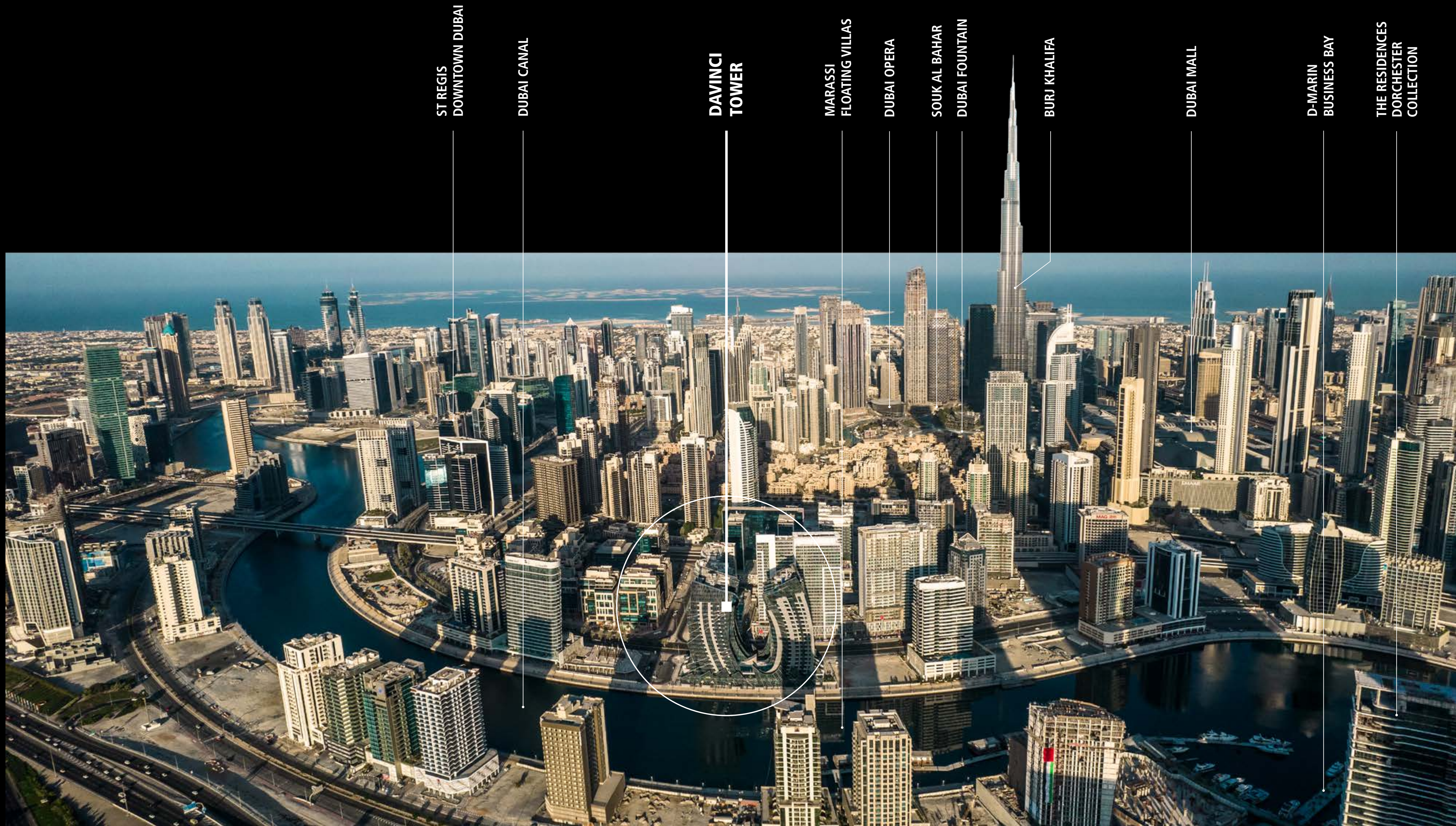

ST REGIS  
DOWNTOWN DUBAI

DUBAI CANAL

DAVINCI  
TOWER

MARASSI  
FLOATING VILLAS

DUBAI OPERA

SOUK AL BAHAR

DUBAI FOUNTAIN

BURJ KHALIFA

DUBAI MALL

D-MARIN  
BUSINESS BAY

THE RESIDENCES  
DORCHESTER  
COLLECTION

# BREATHTAKING *views*

---

The building sits in a strategic position, letting you enjoy the best of Dubai's panoramas. On the South-East side you can indulge in the soothing view of water, with the Canal, the floating villas and the Business Bay at your feet. On the North side, the Burj Khalifa stands just outside of your window.



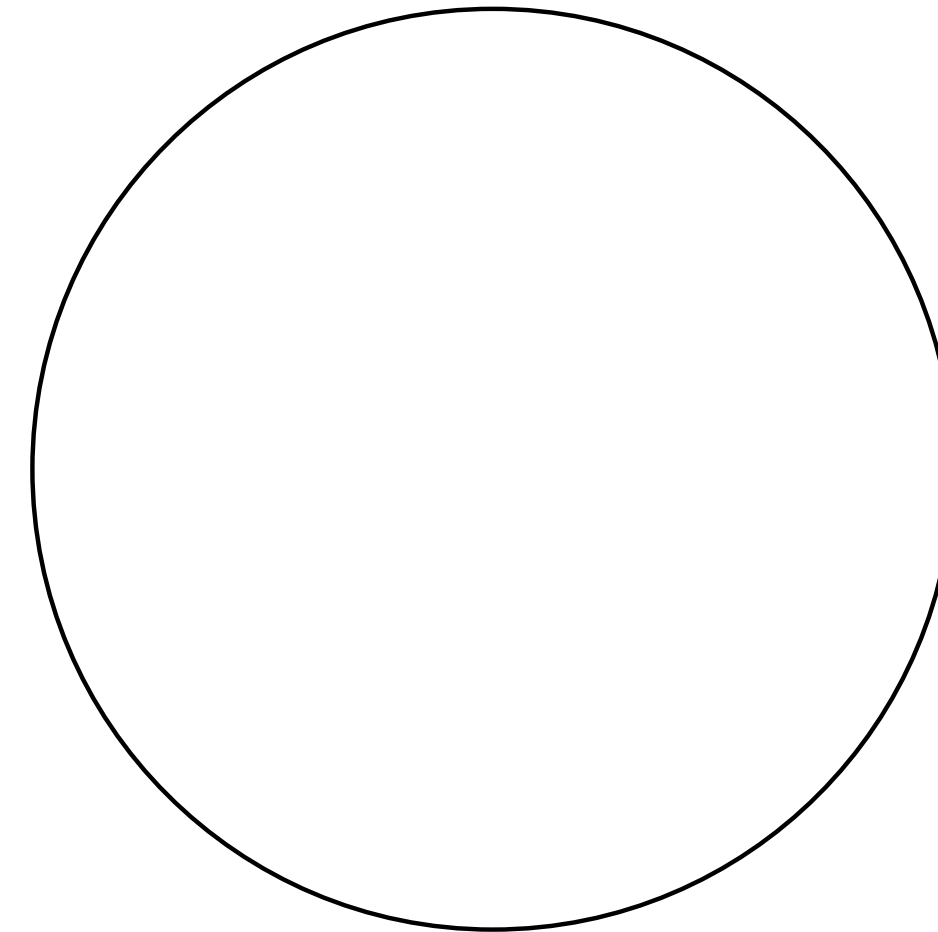
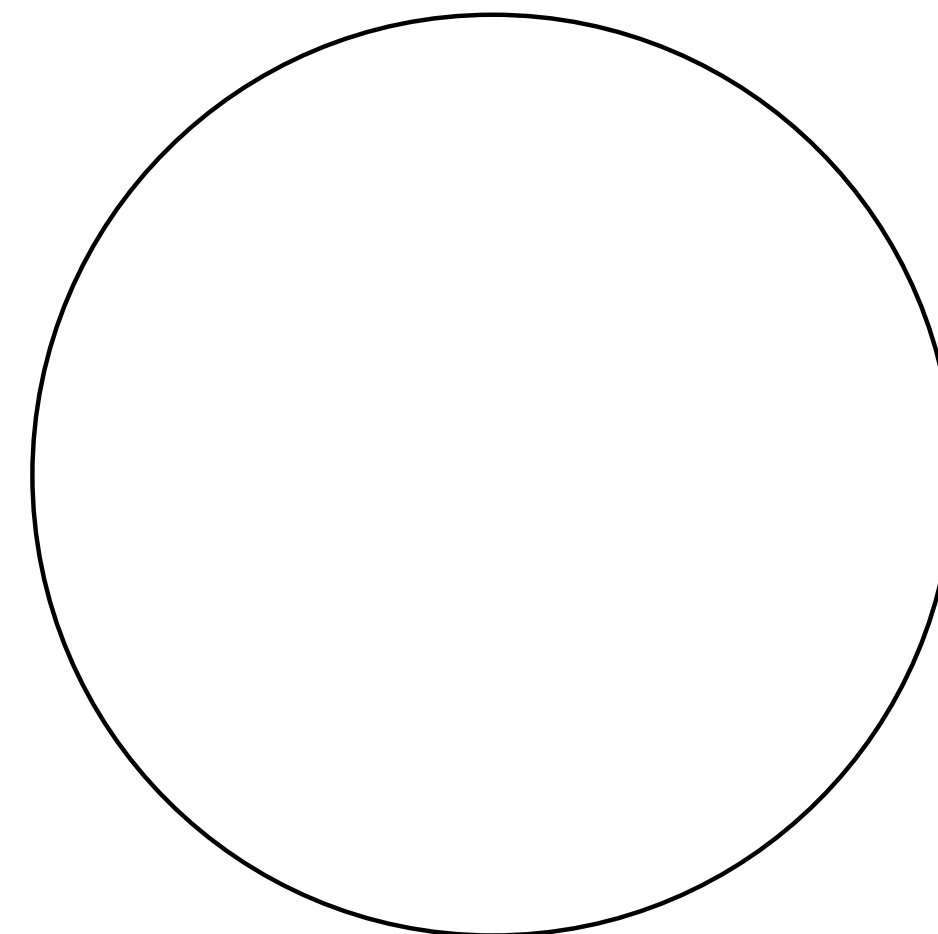

# LIVING *above luxury*

---

For the first time in the world, Pagani's essence takes the shape of a living space: DaVinci Tower is a residential building in downtown Dubai with interiors designed by Pagani. Every detail is crafted to obsession, every material is of the finest quality, every line is designed with taste and harmony, resulting in the unique experience of inhabiting a masterpiece.







# ART ELEVATES *Life*

The magnificent residences set new standards for human living. The expansive 2 - 4 bedroom marble homes are designed with private outdoor spaces and open flowing light-filled interiors, with panoramic views of the canal and Downtown Dubai.

Arrive at your doorstep with luxurious elevators dedicated to residents and guests only, then make yourself at home with advanced domotics that responds to any of your desires.







## THE STEEL ATRIUM

# *Beauty* IS A SHARP BLADE

Inspired by the sinuous curves of Pagani Design, the Steel Atrium represents the epitome of art and luxury. From the moment you walk in, you are are plunged in a masterpiece made of stainless steel, carbon fibers, lush leather and kinetic chandeliers, where the beauty of engineering evokes the most prestigious lifestyle.



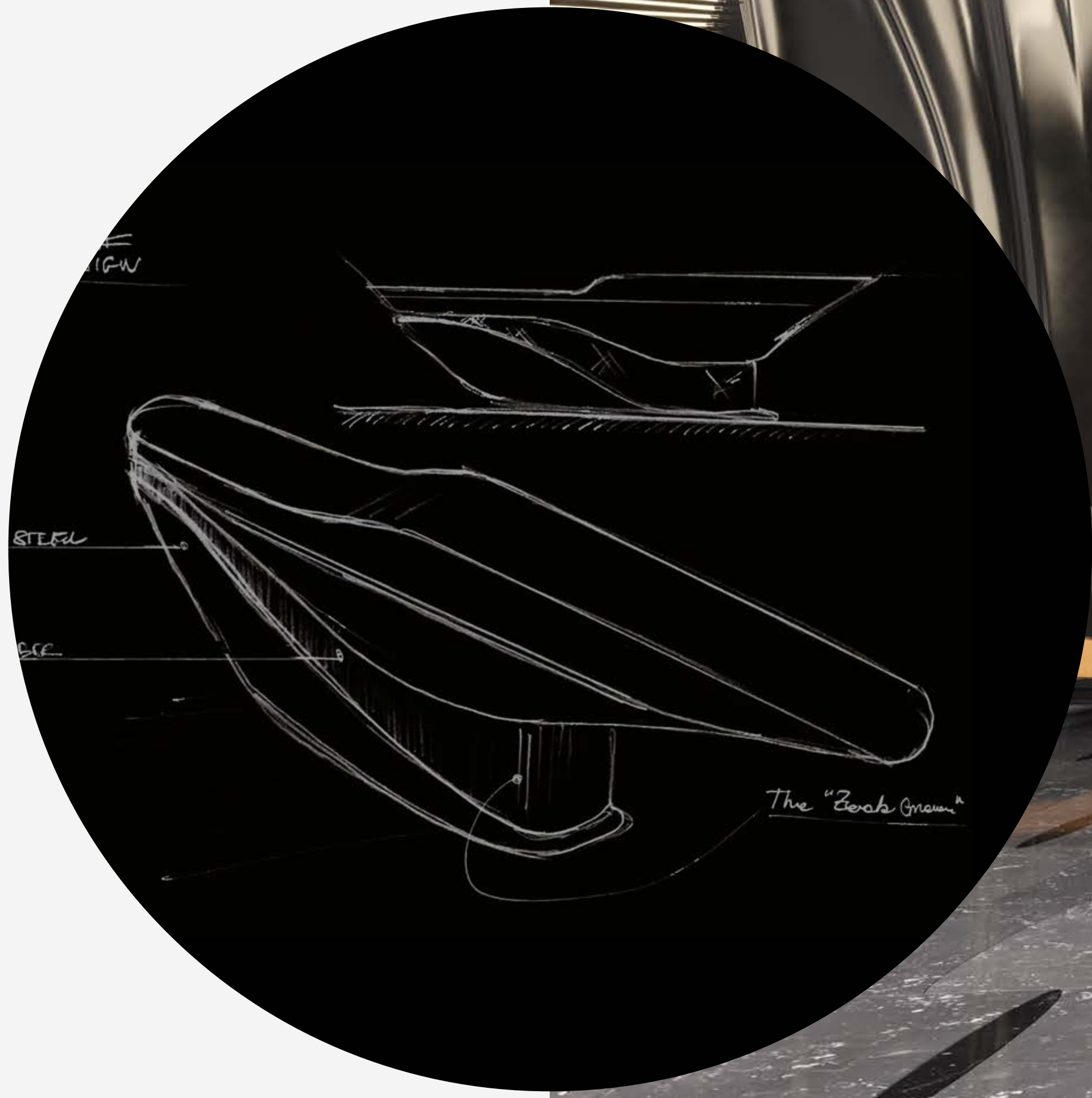
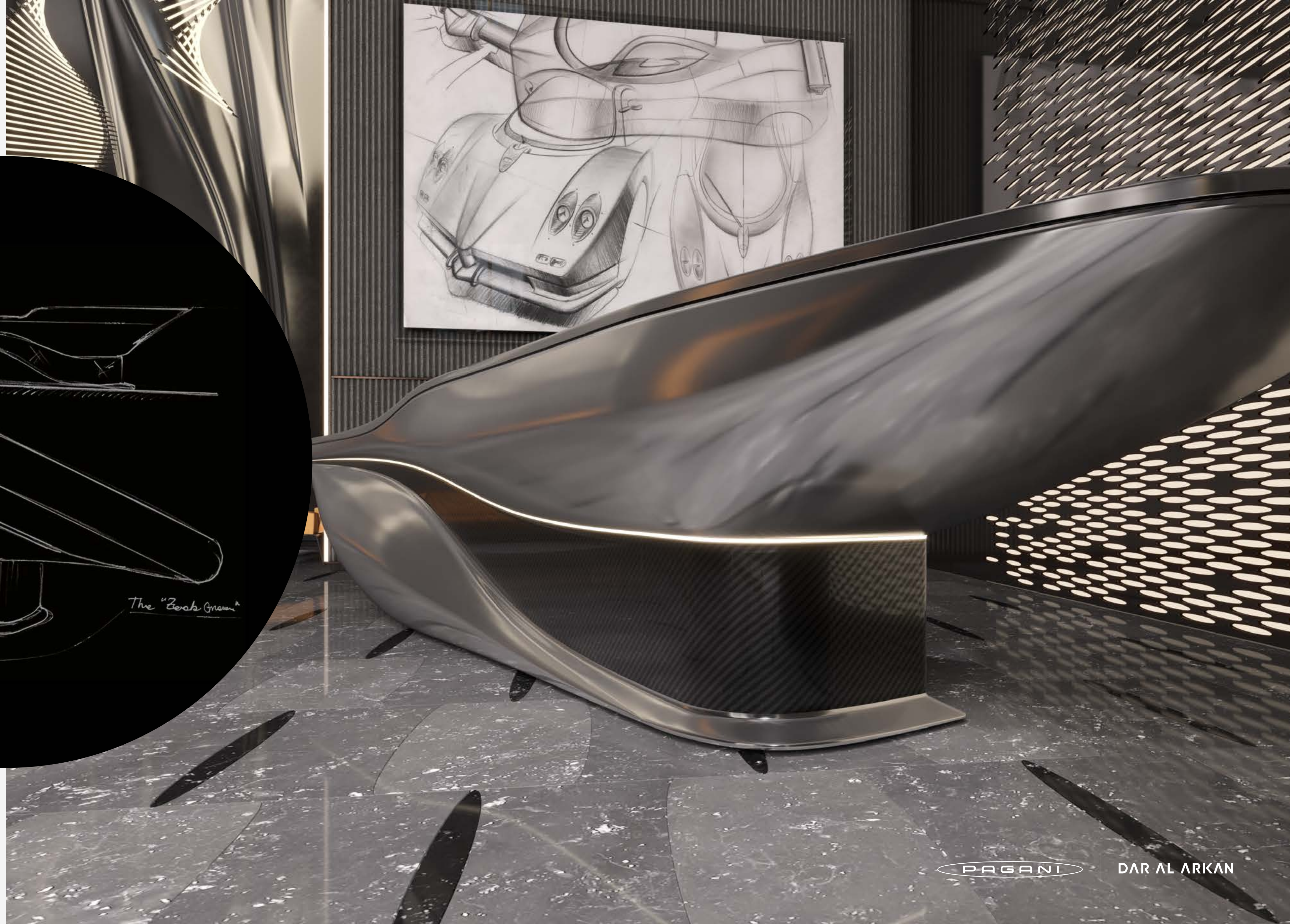

## THE POOL

*Dive* INTO CALMNESS

Peace of mind is within reach when you are surrounded by harmony and balance.

Imagine a relaxing heaven where every shape is designed to please your senses: discover the pool area at the top of the tower, an urban jungle to refresh your ideas after a busy day.



# CONCIERGERIE, *crafted*

---

Nothing is left behind when you live in a world of exclusivity. The residential services will meet any of your desires: our highly professional team will be available 24/7 to help you with housekeeping, arranging dinner plans or making the reservations you need.





# *Inspired* TO WELL-BEING

---

Keep yourself fit and healthy, without having to leave your home. You can workout in a modern gym with the newest equipments and plenty of space to exercise, then give yourself a treat in the sauna and steam rooms for men and women.

A great way to start your day, or to end it.





PAGANI

DAR AL ARKAN





